



Time Delay and Data Dropout Compensation in Networked Control Systems Using Extended Kalman Filter

M. Bagheri, M. Nasiri*

Mechanical Engineering Department, Golpayegan University of Technology, Golpayegan, Isfahan, Iran

ABSTRACT: In networked control systems, time delay and data dropout can degrade the performance of the control system and even destabilize the system. In the present paper, the Extended Kalman filter is employed to compensate the effects of time delay and data dropout in feedforward and feedback paths of networked control systems. In the proposed method, the extended Kalman filter is used as an observer with nonlinear discrete model along with a predictor and a compensator. The predictor provides a sequence of predictions of state variables, and the controller generates a set of control predictions in the future based on the predictor outputs. The compensator chooses the best control signal, among the set of control signals transmitted by the predictor, to compensate for the random network transmission time delay and packet dropout. In the cases with periodic load processes, correlation can be seen in delays between samples, and time delay behavior is captured with the Markov chains model. The dependence between feedback and feedforward delays, are also modeled by letting the distribution of the delays be governed by the state of an underlying Markov chains.

Review History:

Received: 24 August 2018

Revised: 16 December 2018

Accepted: 11 September 2018

Available Online: 19 September 2018

Keywords:

Networked Control System

Time Delay

Compensator

Data Dropout

Extended Kalman Filter

1- Introduction

High accuracy, fast data transfer, and proper performance of control systems are among the features which are very critical in recent decades. The closed-loop control systems generally include components as controller, sensor and actuator, and traditionally point-to-point wired system was used to connect components. The rapid progress of the digital systems, the widespread presence of networks such as the internet, and the advancement of control techniques, have led to the emergence of many trends in the field of networked control systems [1]. The networked control system consists of sensors, actuators and controllers that are located in different places and are interconnected through the exchange of information by the network. Networked control systems have many applications, among which remote control of robots, remote surgery, unmanned vehicles, automation of factories, remote diagnosis and advanced missiles can be mentioned [2]. According to their applications, the networked control systems have different structures, the most important of which are direct structures. The direct structure has several types and is one of the most commonly used direct structure modes in which the controller and the plant are interconnected through a network. In the direct structure, the plant and the controller are located on the both sides of the network [3].

Networked control systems have advantages over traditional wired control systems, including low cost, easy installation and maintenance, reduced wiring volumes, ease of system upgrade, flexibility and remote control capability. However, networked control systems have some disadvantages, the most important of which are the time delay and data dropout during data transmission by the network. In recent years, there have been many studies on networked control

systems. In order to study the effect of time delay and data dropout in networked control systems, the modeling of time delay and data dropout has been performed by different approaches. Three models of network delay are constant time delay, independent random time delay, and time delay with known probability distribution [4]. Also in most cases, data dropout has been studied as independent random data dropout or data dropout with known probability distribution. Time delay and data dropout in a closed loop control system degrade the performance of the system and also can destabilize the system. Schenato [5] compared two zero-input and hold-input control methods in order to compensate for data dropout in networked control systems. Rahmani et al. [6] using the neural network, modeled and predicted the behavior of a linear system, and by considering the time delay as a random variable, they provided a method for the compensation of time delay in networked control systems. They used the Multi-Layer Perceptron (MLP) neural model for compensation of time delay predicted by Markov chains. Wang et al. [7] studied the stability of nonlinear control systems using the H_∞ method and investigated the effect of time delay and data dropout by considering an uncertainty lower than the sampling period. Shi et al. [8] compensated the time delay and data dropout in the sensor to controller path using the optimization of state variable estimation by linear Kalman filter. Ran et al. [9] studied the prediction based on dynamics of the control system by taking into account the uncertainty in the plant model. They considered linear time delay and data dropout as a random variables and assumed the system model to be linear. Hu et al. [10] examined control performance for networked control systems with consecutive time delay and data dropout. Liu et al. [11] proposed a new control prediction design for networked control systems

Corresponding author, E-mail: nasiri@gut.ac.ir

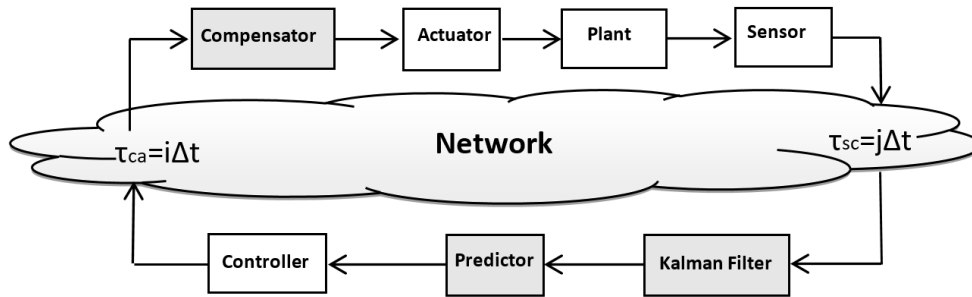

Fig 1. Time Delay and Data Dropout Compensation in Networked Control System Using Kalman Filter, Predictor and Compensator

which have time delays in sensor to controller and controller to actuator paths. Using the linear model of the plant, they obtained a sequence of control predictions, and then it was transmitted to the actuator, and the actuator chose the most appropriate data to compensate for the time delay. Hu et al. [12] used a fuzzy control algorithm and Smith method to compensate for the time delay in networked control systems. They provided a fuzzy adaptive PID controller with Smith's prediction. Using a discrete nonlinear model of the plant and taking advantage of Lyapunov-Krasovskii stability theorem, Peng et al. in [13] derived the maximum allowable delay bound and the feedback gain of a controller by solving a set of linear matrix inequalities. In [16], the prediction method based on MPC model for linear systems to compensate for the effect of time delay and data dropout was studied. The authors of [17] dealt with the compensation for data dropout in the linear networked control system using the fractional-order Kalman filter method. Fulto et al. [18] utilized two methods of neutral and extended Kalman filters to compensate for the data dropout in nonlinear systems and compared their performance with each other. Khan et al. [19] investigated the positioning and tracking performance of extended Kalman filter in wireless sensors network. Further, localization performance under varying number of sensors was also evaluated.

In the present paper, the extended Kalman filter method is used to compensate for the effect of time delay and data dropout in a nonlinear networked control system with a direct structure. According to the considered structure, time delay and data dropout in sensor-to-controller (feedback) and controller-to-actuator (feedforward) paths are compensated. In realistic networked communication systems, time delay at any time is correlated with time delay in the previous time, and therefore, Markov chain is used for modeling the time delay and data dropout behavior. The time delay in the feedforward path is also dependent on the time delay in the feedback path, therefore Markov chain is applied to estimate the time delay in the feedforward path based on the time delay in the feedback path.

2- Compensation for Time Delay and Data Dropout

In order to compensate for the effect of time delay and random data dropout on data transmission in the networked control systems in feedback (sensor-to-controller) and feedforward (controller-to-actuator) paths, a structure as in Fig. 1 is used. In this structure, the controller is an LQR controller which is designed based on a system with no time delay and data dropout. This structure is designed to compensate for the effect of time delay and data dropout and consists of three parts, which are briefly described in the following sections.

2- 1- Kalman Filter

In this method, the outputs measured by the sensor are transmitted through the network in the feedback path. The Kalman filter, as an observer, estimates the state variables based on the outputs that have a time delay and data dropout in the feedback path.

2- 2- Predictor

Based on the Kalman filter output, which is an estimate of state variables, the predictor provides a sequence of predicted state variables. The estimated and predicted future control inputs are integrated in a packet and transmitted over the network to the actuator.

2- 3- Compensator

According to the time delay and data dropout in the feedforward path, the compensator chooses the appropriate control values from the control prediction sequence.

3- Nonlinear Model

The plant is defined by a discrete nonlinear system with the following difference equations in the state space.

$$\mathbf{x}_{k+1} = \mathbf{f}(\mathbf{x}_k, \mathbf{u}_k, \mathbf{w}_k) \quad (1)$$

$$\mathbf{y}_k = \mathbf{g}(\mathbf{x}_k, \mathbf{v}_k) \quad (2)$$

where $\mathbf{u}_k \in \mathbb{R}^m$ is the vector of system inputs, $\mathbf{x}_k \in \mathbb{R}^n$ is the vector of system state variables, and $\mathbf{y}_k \in \mathbb{R}^p$ is the vector of system output. $\mathbf{w}_k \in \mathbb{R}^n$ and $\mathbf{v}_k \in \mathbb{R}^p$ are the process and output noise vector, respectively, and they are considered as a white noise with covariances $\mathbf{Q} \in \mathbb{R}^{n \times n}$ and $\mathbf{R} \in \mathbb{R}^{p \times p}$. The considered assumptions are as it follows.

- The system is completely controllable and observable.
- The maximum time delay in the feedback and forward paths are positive integers N_1 and M_1 .
- The maximum data dropout in feedback and feedforward paths are positive integers N_d and M_d . If the data packet is not delivered at a destination in a certain transmission time, it means that the data packet is dropped out, based on the commonly used network protocols. It is assumed that only a finite number of consecutive data dropout can be tolerated in order to avoid the networked control system becoming open loop [11].

4- Time Delay and Data Dropout Modeling Using Markov Chain

In realistic networked communication systems, the time delay at time k is correlated to time delay of the previous

time. Given this property, Markov chain is used to model the random behavior of time delay in networked communication. If the delay time in the feedback path is selected as a factor of the sampling time (Δt), then the time delay is expressed as follows.

$$\tau = j\Delta t, \quad j \in \{0 \ 1 \ 2 \ \dots \ N_1\} \quad (3)$$

where N_1 represents the maximum time delay in the feedback path. To model Markov chain, a transition probability matrix (P_{sc}) is defined by Eq. (4):

$$P_{sc} = [p_{mn}] \quad m, n < N_1 \quad (4)$$

where, P_{mn} indicates the probability for the delay $n\Delta t$ provided that the delay in previous sample time is $m\Delta t$, as it follows.

$$p_{mn} = \Pr(\tau_{k+1} = n\Delta t \mid \tau_k = m\Delta t) \quad (5)$$

The transition probability matrix P_{sc} has the properties stated in Eq. (6).

$$p_{mn} > 0, \quad \sum_{n=0}^{k_{max}} p_{mn} = \sum_{m=0}^{k_{max}} p_{mn} = 1 \quad (6)$$

Due to the fact that the networked control system is a bidirectional connection and the time delay in the feedforward path is also dependent on the time delay in the feedback path, in this paper a transition probability matrix, P_{ca} , is also defined as Eq. (7).

$$P_{ca} = [p'_{ij}] \quad i < M_1, \quad j < N_1 \quad (7)$$

Where p'_{ij} represents the probability for delay of $i\Delta t$ in the feedforward path provided that the delay in the feedback path is $j\Delta t$, as follows.

$$p_{ij} = \Pr(\tau_{ca} = i\Delta t \mid \tau_{sc} = j\Delta t) \quad (8)$$

where τ_{sc} and τ_{ca} represent the time delays in the feedback path (sensor-to-controller) and feedforward path (controller-to-actuator), respectively. The properties stated for the matrix P_{sc} in Eq. (6) also apply to the matrix P_{ca} . Modeling the number of data dropout in feedback and feedforward paths is also similar to the time delay modeling.

5- Compensation for Effect of Time Delay and Data Dropout in Feedback Path

The extended Kalman filter is used as an observer to estimate state variables, and the set of relations associated with the extended Kalman filter is expressed in Eq. (9-13) [14].

$$\hat{\mathbf{x}}_{k|k-1} = \mathbf{f}(\hat{\mathbf{x}}_{k-1|k-1}, \mathbf{u}_{k-1}, 0) \quad (9)$$

$$\hat{\mathbf{x}}_{k|k} = \hat{\mathbf{x}}_{k|k-1} + \gamma_k \mathbf{K}_k [\mathbf{y}_k - \mathbf{g}(\hat{\mathbf{x}}_{k|k-1}, 0)] \quad (10)$$

$$\mathbf{P}_{k|k-1} = \mathbf{A} \mathbf{P}_{k-1|k-1} \mathbf{A}^T + \mathbf{G} \mathbf{Q} \mathbf{G}^T \quad (11)$$

$$P_{k|k} = (I - \gamma_k K_k C) P_{k|k-1} (I - \gamma_k K_k C)^T + \gamma_k K_k H R H^T K_k^T \quad (12)$$

$$\mathbf{K}_k = \mathbf{P}_{k|k-1} \mathbf{C}^T (\mathbf{C} \mathbf{P}_{k|k-1} \mathbf{H}^T + \mathbf{H} \mathbf{R} \mathbf{H}^T) \quad (13)$$

where, $\mathbf{A} = \nabla \mathbf{f}_x$ and $\mathbf{G} = \nabla \mathbf{f}_w$ represent the Jacobian of state transition equation. Also, $\mathbf{C} = \nabla \mathbf{g}_x$ and $\mathbf{H} = \nabla \mathbf{g}_v$ indicate the Jacobian of the measurement equation. $\mathbf{P} \in \mathbb{R}^{n \times n}$ is the error

covariance matrix and $\mathbf{K} \in \mathbb{R}^{n \times p}$ is the Kalman gain matrix. The index k is used to represent sampling time ($\tau = k\Delta t$), and $\hat{\mathbf{x}}_{k|j}$ represents the estimate of \mathbf{x} at time k based on the given output \mathbf{y} up to time j as in Eq. (14).

$$\hat{\mathbf{x}}_{k|j} = E(\mathbf{x}_k \mid y_0, y_1, \dots, y_j) \quad (14)$$

where, $\mathbf{P}_{k|j}$ is the covariance matrix of the error, which is obtained according to Eq. (15).

$$\mathbf{P}_{k|j} = E[(\mathbf{x}_k - \hat{\mathbf{x}}_{k|j})(\mathbf{x}_k - \hat{\mathbf{x}}_{k|j})^T] = E[\mathbf{e}_{k|j} \mathbf{e}_{k|j}^T] \quad (15)$$

In Eq. (14-15), the operator $E(\cdot)$ expresses the mathematical expectation. The sequence of outputs measured by the sensor and the input of the system are transmitted to the controller at each sample time through the network. The Kalman filter estimates the state variables based on delayed and dropped out data. The effect of data dropout on the estimation of state variables by the Kalman filter was shown in Eq. (9-13) using parameter γ_k . If $\gamma_k = 1$, it means the data transmitted through the network has received by the Kalman filter at time k , otherwise $\gamma_k = 0$.

$$\hat{\mathbf{x}}_{k-j|k-j} = \hat{\mathbf{x}}_{k-j|k-j-1} + \gamma_{k-j} \mathbf{K}_{k-j} [\mathbf{y}_{k-j} - \mathbf{g}(\hat{\mathbf{x}}_{k-j|k-j-1}, 0)] \quad (16)$$

The following equation can be obtained using Eq. (9).

$$\hat{\mathbf{x}}_{k+1|k} = \mathbf{f}(\hat{\mathbf{x}}_{k|k}, \mathbf{u}_k, 0) \quad (17)$$

Eq. (16) represents the prediction of the state variables at time $k+1$ by using the output up to time k . Thus, the predictor applies Eq. (16-17) in order to predict the state variables for compensating the time delay and the data dropout assumed in the feedback path using Eq. (18-21).

$$\hat{\mathbf{x}}_{k-j+1|k-j} = \mathbf{f}(\hat{\mathbf{x}}_{k-j|k-j}, \mathbf{u}_{k-j}, 0) \quad (18)$$

$$\hat{\mathbf{x}}_{k-j+2|k-j} = \mathbf{f}(\hat{\mathbf{x}}_{k-j+1|k-j}, \mathbf{u}_{k-j+1}, 0) \quad (19)$$

$$\vdots \quad (20)$$

$$\hat{\mathbf{x}}_{k|k-j} = \mathbf{f}(\hat{\mathbf{x}}_{k-1|k-j}, \mathbf{u}_{k-1}, 0) \quad (21)$$

6- Compensation for the Effect of Time Delay and Data Dropout in Feedforward Path

In order to compensate for the effect of time delay and data dropout in the feedforward path, the predictor predicts the state variables in the future. The prediction of the state variables in the future will be carried out according to the Eq. (22-25). The purpose of making prediction up to the time $k + M_1 + M_d$ is to compensate for the effects of time delay and data dropout in the feedforward path.

$$\hat{\mathbf{x}}_{k+1|k-j} = \mathbf{f}(\hat{\mathbf{x}}_{k|k-j}, \mathbf{u}_{k|k-j}, 0) \quad (22)$$

$$\hat{\mathbf{x}}_{k+2|k-j} = \mathbf{f}(\hat{\mathbf{x}}_{k+1|k-j}, \mathbf{u}_{k+1|k-j}, 0) \quad (23)$$

$$\vdots \quad (24)$$

$$\hat{\mathbf{x}}_{k+M_1+M_d|k-j} = \mathbf{f}(\hat{\mathbf{x}}_{k+M_1+M_d-1|k-j}, \mathbf{u}_{k+M_1+M_d-1|k-j}, 0) \quad (25)$$

The Eq. (22) represent the prediction of the state variables at time $k+1$ with respect to the output at time $k-j$. An optimal LQR controller is used with the state feedback gain L . Based on the state variables obtained from Eq. (22-25), the controller obtains a set of control predictions in the future time using Eq. (26-29) and then transmits the sequence of control predictions to the compensator through the network.

$$\mathbf{u}_{k|k-j} = L\hat{\mathbf{x}}_{k|k-j} \quad (26)$$

$$\mathbf{u}_{k+1|k-j} = L\hat{\mathbf{x}}_{k+1|k-j} \quad (27)$$

⋮

$$\mathbf{u}_{k+M_1|k-j} = L\hat{\mathbf{x}}_{k+M_1|k-j} \quad (28)$$

⋮

$$\mathbf{u}_{k+M_1+M_d|k-j} = L\hat{\mathbf{x}}_{k+M_1+M_d|k-j} \quad (29)$$

If the time delay in the feedforward path is i , where $i \leq M_1$, then the packet associated with the set of control predictions arrives at the compensator at the time $k-i$. Therefore, the compensator chooses the input value of the system using the received packet and the time delay in the feedforward path. Eq. (30-34) represent the set of control predictions at time $k-i$.

$$\mathbf{u}_{k-i|k-i-j} = L\hat{\mathbf{x}}_{k-i|k-i-j} \quad (30)$$

$$\mathbf{u}_{k-i+1|k-i-j} = L\hat{\mathbf{x}}_{k-i+1|k-i-j} \quad (31)$$

⋮

$$\mathbf{u}_{k|k-i-j} = L\hat{\mathbf{x}}_{k|k-i-j} \quad (32)$$

⋮

$$\mathbf{u}_{k-i+M_1|k-i-j} = L\hat{\mathbf{x}}_{k-i+M_1|k-i-j} \quad (33)$$

⋮

$$\mathbf{u}_{k-i+M_1+M_d|k-i-j} = L\hat{\mathbf{x}}_{k-i+M_1+M_d|k-i-j} \quad (34)$$

Thus, according to the time delay i in the feedforward path, the compensator transmits $\mathbf{u}_{k|k-i-j}$ as the system input to the actuator as it follows.

$$\mathbf{u}_k = \mathbf{u}_{k|k-i-j} = L\hat{\mathbf{x}}_{k|k-i-j} \quad (35)$$

If the packet related to the set of control predictions is not received by the compensator at $k-i$ time, it means that the packet has been lost. Therefore, the compensator uses the packet related to the set of control predictions at the time

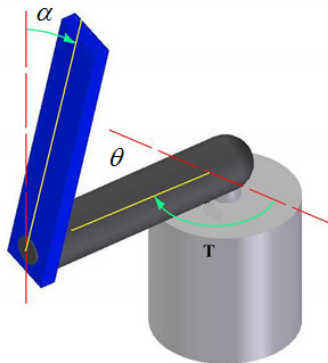

Fig. 2. Schematic of a Rotary Inverted Pendulum

$k-i-1$. Based on this packet and the number of time delays and data dropouts, the compensator transmits $\mathbf{u}_{k|k-i-j}$ to the actuator.

7- Mathematical Model

In order to evaluate the proposed method, the rotary inverted pendulum is considered as a controlled system. Fig. 2 shows the representation of a rotary inverted pendulum, where α is the pendulum angle and θ is the angle of the horizontal arm. The specification of the rotary inverted pendulum are presented in Table 1.

Table 1. Specification of rotary inverted pendulum

| Symbol | Concept | Value |
|--------|----------------------------|--------------------------|
| M | Arm mass | 0.1188 kg |
| m | Pendulum mass | 0.0346 kg |
| r | Arm length | 0.2 m |
| L | Pendulum length | 0.68 m |
| J_o | Arm moment of inertia | 0.0073 kg.m ² |
| J_b | Pendulum moment of inertia | 0.0013 kg.m ² |
| b | Arm viscous coefficient | 0.0064 N/(m.sec) |
| g | Gravity acceleration | 9.81 m/sec ² |

The nonlinear relation between θ and α in a rotary inverted pendulum is given by Eq. (36) [15].

$$(J_B + mL^2)\ddot{\alpha} - mLr\cos(\alpha)\ddot{\theta} - mgL\sin(\alpha) = 0 \quad (36)$$

In the rotary inverted pendulum, $\ddot{\theta}$ is assumed as the control input and α as the output of the system [1]. To obtain the system model in state space, the state variables and the output are defined as it follows.

$$\mathbf{x} = [\theta \quad \dot{\theta} \quad \alpha \quad \dot{\alpha}]^T \quad (37)$$

$$y = [\alpha \quad \theta]^T \quad (38)$$

Therefore, the governing equations of the system in state space will be as it follows.

$$\dot{\mathbf{x}} = \begin{bmatrix} \mathbf{x}(2) \\ \mathbf{u} \\ \mathbf{x}(4) \\ \left(\frac{mgL}{J_B + mL^2}\right)\sin \mathbf{x}(3) + \left(\frac{mLr}{J_B + mL^2}\right)\mathbf{u} \cos \mathbf{x}(3) \end{bmatrix} + \mathbf{w} \quad (39)$$

The Euler method with sampling period $T = 0.01$ sec is used to obtain the discretized state space model (39). Therefore, the discretized nonlinear model of the rotary inverted pendulum is achieved as in Eq. (40).

$$\mathbf{x}_{k+1} = \mathbf{x}_k + T \begin{bmatrix} \mathbf{x}_k(2) \\ \mathbf{u}_k \\ \mathbf{x}_k(4) \\ \left(\frac{mgL}{J_B + mL^2}\right)\sin \mathbf{x}_k(3) + \left(\frac{mLr}{J_B + mL^2}\right)\mathbf{u}_k \cos \mathbf{x}_k(3) \end{bmatrix} + \mathbf{w}_k \quad (40)$$

The process and output noises \mathbf{w} and \mathbf{v} are white noises

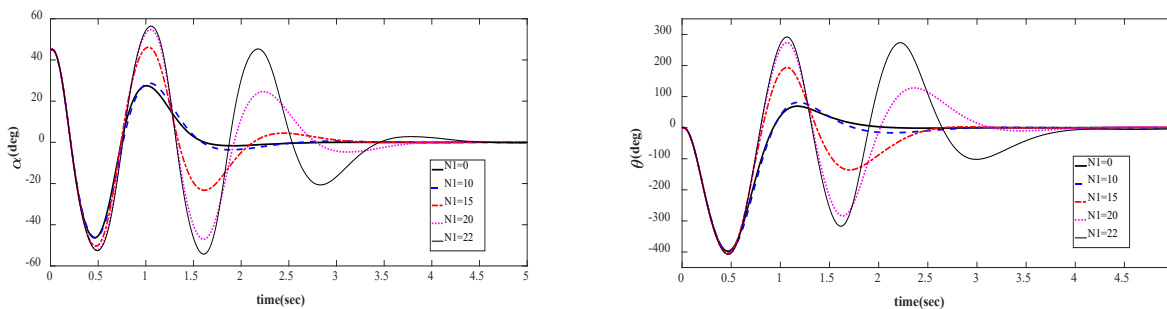

Fig. 3. Effect of Maximal Time Delay in the Feedback Path (N_1) with $M_1=0$

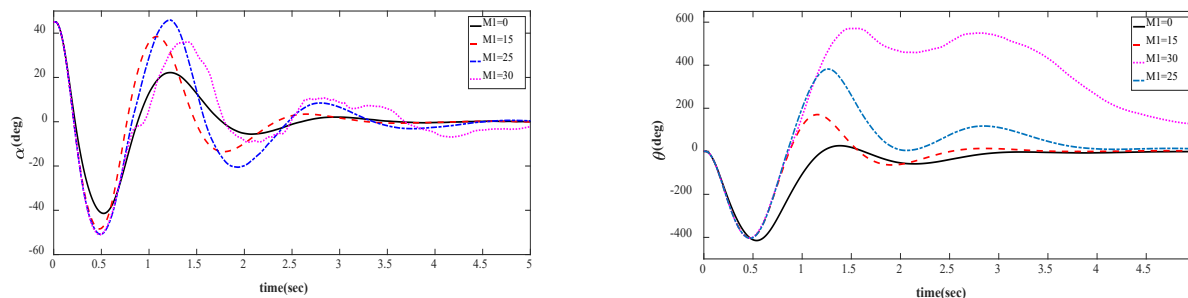

Fig. 4. Effect of maximum time delay in feedforward path (M_1) when with $N_1=0$

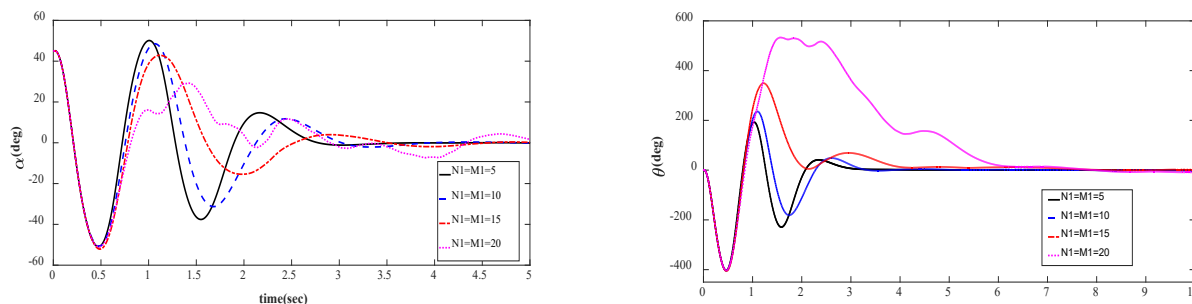

Fig. 5. Effect of maximum time delay in feedforward path (M_1) and feedback path (N_1) simultaneously when $M_1 = N_1$

with covariance \mathbf{Q} and \mathbf{R} , respectively, as presented in Eq. (41-42).

$$\mathbf{Q} = \sigma_w^2 \begin{bmatrix} 1 & 0 & 0 & 0 \\ 0 & 1 & 0 & 0 \\ 0 & 0 & 1 & 0 \\ 0 & 0 & 0 & 1 \end{bmatrix}, \quad \sigma_w = 1 \times 10^{-5}, \quad (41)$$

$$\mathbf{R} = \sigma_v^2, \quad \sigma_v = 1 \times 10^{-3}. \quad (42)$$

8- Results

The investigations performed in the present study aimed at compensating for the time delay and data dropout in the networked control of a nonlinear rotary inverted pendulum. Since the extended Kalman filter is employed for nonlinear systems, the initial conditions of the system are considered relatively large as $\alpha(0)=45$ deg. The maximum time delay effect in the feedback path (N_1) when $M_1=0$, is examined as shown in Fig. 3. According to the figure, when N_1 increases, the stability of the system decreases, and when $N_1=23$, the system becomes completely unstable and the proposed method cannot stabilize the system.

In Fig. 4, the effect of the maximum delay time on the feedforward path (M_1), while $N_1=0$, is investigated. As shown in the figure, when M_1 increases, the stability of the system decreases, and when $M_1=13$, the system becomes completely unstable.

In Fig. 5, the effect of maximum time delay in feedforward path (M_1) and feedback path (N_1) are simultaneously investigated. In this paper, it is assumed that $M_1=N_1$. According to the figure, when both M_1 and N_1 increase simultaneously, the stability of the system decreases.

In Fig. 6, a comparison is made between the network control system in a scenario in which $N_1=20$ and $M_1=0$ with the one in which $N_1=0$ and $M_1=20$. As seen, the stability of the system in the state where the time delay only exists in the feedback path, is less than the case where there is a time delay only in the feedforward path. Therefore, the time delay in the feedback path has relatively greater effects.

According to Fig. 3-6, the signal-to-noise ratio is high and the effects of noise on the system is not observed; therefore, to investigate the effect of the extended Kamen filter as the observer in the estimation of state variables in Fig. 7, the system is studied with initial conditions $\alpha(0)=1$ deg, indicating the proper performance of the observer in estimating the angle of the pendulum.

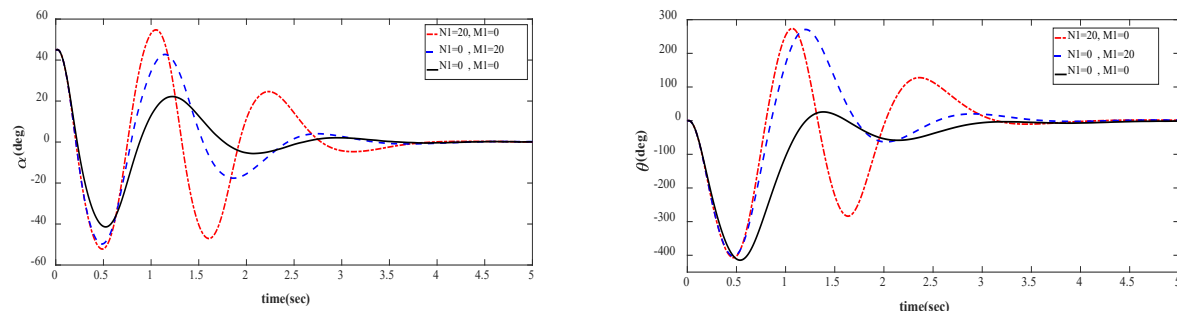

Fig. 6. Effect of time delay in feedback and forward paths on performance of the networked control system

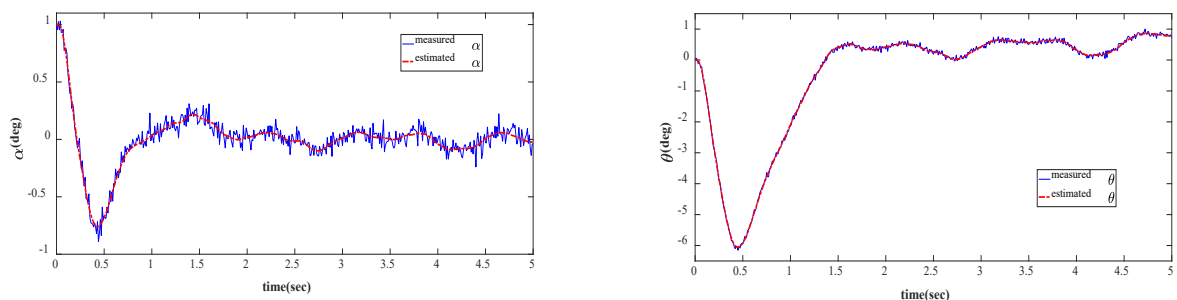

Fig. 7. Effect of the extended Kalman filter on the estimation of the pendulum angle in the presence of noise

9- Conclusion

The time delay and random data dropout result in the instability of networked control systems. The structure proposed in this study is used to compensate for the effects of time delay and data dropout on both feedback and feedforward paths. When the controlled system is nonlinear, the extended Kalman filter is applied as an observer of state variables. The proposed structure includes the extended Kalman filter as an observer, a predictor to estimate state variables in future periods, and a compensator to select the appropriate control signal among a set of signals sent by the controller. Here, Markov chain is used to model the time delay and data dropout in the feedback and feedforward paths. The simulation results indicate that the time delay and data dropout in the feedback path is more effective than the feedforward path and can more quickly make the system unstable. Also the presented structure shows the proper performance of the extended Kalman filter in compensation of time delay in networked control system for nonlinear models. In a system without a compensator, the system becomes unstable in spite of the fact that $M_1 = N_1 = 5$ while by employing the proposed structure, the time delays $M_1 = N_1 = 20$ is tolerable and the system remains stable.

List of Symbols

| | |
|-----------|---|
| A, B, C | Coefficients matrices |
| b | viscous friction coefficient arm (N/ (m.sec)) |
| g | Gravity acceleration (m/sec ²) |
| J | Pendulum length to the center of its mass |
| K | Gain of the Kalman filter |
| L | Pendulum moment of inertia (kg.m ²) |

| | |
|------------|---|
| M, m | Pendulum length (m) |
| M_1, M_d | Maximum delay time and data dropout in the feedforward path |
| N_1, N_d | Maximum delay time and data dropout in the feedback path |
| P | Error covariance matrix |
| Q | Process noise covariance matrix |
| R | Output noise covariance matrix |
| u_k | System inputs vector |
| v_k | Output noise vector |
| w_k | Process noise vector |
| x_k | System state variables vector |
| \hat{x} | Estimated state variables vector |
| y_k | System output vector |

Greek symbols

| | |
|--------------|---|
| α | Pendulum angle |
| θ | Arm angle |
| γ_k | The parameter representing data dropout |
| ∇f_x | Jacobian matrix of $f(\cdot)$ relative to x |
| ∇f_w | Jacobian matrix of $f(\cdot)$ relative to w |
| ∇g_x | Jacobian matrix of $g(\cdot)$ relative to x |
| ∇g_v | Jacobian matrix of $g(\cdot)$ relative to v |

References

- [1] J.R. Moyne, D.M. Tilbury, The emergence of industrial control networks for manufacturing control, diagnostics, and safety data, *Proceedings of the IEEE*, 95(1) (2007) 29-47.
- [2] R.A. Gupta, M.-Y. Chow, *Networked Control Systems: Theory and Applications*, (2008).
- [3] Y. Tipsuwan, M.-Y. Chow, Control methodologies in networked control systems, *Control engineering practice*, 11(10) (2003) 1099-1111.
- [4] R.A. Gupta, M.-Y. Chow, Networked control system: Overview and research trends, *IEEE transactions on industrial electronics*, 57(7) (2010) 2527-2535.
- [5] L. Schenato, To zero or to hold control inputs with lossy links?, *IEEE Transactions on Automatic Control*, 54(5) (2009) 1093-1099.
- [6] B. Rahmani, D. Markaziii, H. Amir, Markovian delay prediction-based control of networked systems, *AUT Journal of Modeling and Simulation*, 42(1) (2010) 21-28.
- [7] Y. Wang, H.R. Karimi, Z. Xiang, Control for networked control systems with time delays and packet dropouts, *Mathematical Problems in Engineering*, 86(10) (2013) 1824-1836.
- [8] L. Shi, L. Xie, R.M. Murray, Kalman filtering over a packet-delaying network: A probabilistic approach, *Automatica*, 45(9) (2009) 2134-2140.
- [9] A. Bao-Ran, Y. Bin, Dynamic output feedback control for networked predictive control systems with uncertainties, *International Journal of Control and Automation*, 9(8) (2016) 149-156.
- [10] Z. Hu, F. Deng, Robust H_∞ control for networked systems with transmission delays and successive packet dropouts under stochastic sampling, *International Journal of Robust and Nonlinear Control*, 27(1) (2017) 84-107.
- [11] G.-P. Liu, Y. Xia, J. Chen, D. Rees, W. Hu, Networked predictive control of systems with random network delays in both forward and feedback channels, *IEEE Transactions on Industrial Electronics*, 54(3) (2007) 1282-1297.
- [12] J. Hu, H. Zhang, G. Wu, Simulation design of controller for networked control system, *International Journal of Control and Automation*, 9(1) (2016) 123-132.
- [13] C. Peng, Y.C. Tian, M.O. Tade, State feedback controller design of networked control systems with interval time-varying delay and nonlinearity, *International Journal of Robust and Nonlinear Control: IFAC-Affiliated Journal*, 18(12) (2008) 1285-1301.
- [14] M.I. Ribeiro, Kalman and extended kalman filters: Concept, derivation and properties, *Institute for Systems and Robotics*, 43 (2004).
- [15] J. Driver, D. Thorpe, Design, build and control of a single/double rotational inverted pendulum, *The University of Adelaide, School of Mechanical Engineering, Australia*, 4 (2004).
- [16] T. Mori, Y. Kawamura, T. Zanma, K. Liu, Compensation of networked control systems with time-delay, in: 2014 IEEE 13th International Workshop on Advanced Motion Control (AMC), IEEE, 2014, pp. 752-757.
- [17] P. Feng, L. Lu, X. Dingyu, Compensation for network data dropouts based on modified fractional-order Kalman filter, in: The 27th Chinese Control and Decision Conference (2015 CCDC), IEEE, 2015, pp. 348-352.
- [18] T.C. Foletto, U.F. Moreno, A.M. Lopes, Comparison of packet loss compensation in nonlinear networked control systems using the methods extended Kalman filter and unscented Kalman filter, in: ETFA2011, IEEE, 2011, pp. 1-7.
- [19] R. Khan, S.U. Khan, S. Khan, M.U.A. Khan, Localization performance evaluation of extended Kalman filter in wireless sensors network, *Procedia Computer Science*, 32 (2014) 117-124.

Please cite this article using:

M. Bagheri and M. Nasiri, Time Delay and Data Dropout Compensation in Networked Control Systems Using Extended Kalman Filter, *AUT J. Model. Simul.*, 50(2) (2018) 181-188.
DOI: 10.22060/miscj.2018.14879.5116



