



## Experimental and Analytical Study of new Proposed Semi-rigid Concrete Bam-to-Column Connection

R. Morshed, H. R. Shayegh, M. R. Mirjalili \*

Department of Civil Engineering, Yazd University, Yazd, Iran

**ABSTRACT:** A new semi-rigid concrete beam-to-column connection is proposed and its performance is investigated through experimental and analytical studies. In this connection, the beam does not directly connect to column but it is connected with torsional link member. This scissor mechanism allows the beam to make rotation with respect to column. Moreover, the strengthened connections are also suggested to support higher levels of lateral deformations for structures located in high risk seismic areas. The connections behavior under cyclic loads has been studied experimentally using three types of specimens; i) basic specimen, ii) strengthened specimen with Carbon Fiber Reinforced Polymer (CFRP) wrapping, iii) strengthened specimen with steel core reinforcing. The results showed that for low levels of deformations, the basic connection exhibited acceptable performance but for higher levels of rotation, the strengthened specimens had significant merits in ductility and nonlinear characteristics. Beside the experimental tests, the numerical model of connection was constructed using ABAQUS program. The accuracy of modeling was verified through experimental results. To investigate the effect of using proposed semi-rigid connection in seismic demands of concrete structures, two rigid and semi-rigid three-story frames were modeled in OpenSees. Several non-linear dynamic analyses were carried on models and the different global and local demands were compared. The results showed that in low-rise or non-sway buildings in which the lateral displacements are not very considerable, semi-rigid connections can lead to smaller seismic loads and consequently the economical and optimal design.

### Review History:

Received: 16 September 2018  
Revised: 30 October 2018  
Accepted: 31 October 2018  
Available Online: 15 November 2018

### Keywords:

Concrete Semi-rigid Connection  
Beam-to-column Connection  
Torsion in Concrete Beams  
Torsional Behavior  
Torsional Connection

### 1- Introduction

In the past 20 years, many researchers have attempted to evaluate the frames with semi-rigid connections using analytical and experimental methods. Some analytical studies have focused on the modeling of these connections and discussed about their characteristics [1-3]. Several numerical studies have been done to evaluate the seismic behavior of the semi-rigid frames [4-9]. Moreover, several experimental researches have been conducted to evaluate the performance of the semi-rigid systems [10-17]. The test data and detailed bibliography on connection tests can be found in SSRC [18] and Nethercot reports [19]. The structures with flexible (simple) and semi-rigid connections are rarely recommended in seismic zones due to the possible excessive deformation in connections and, consequently, large story drift responses during strong ground motions. The design codes do not have provisions on analyzing and designing the semi-rigid and flexible connections as the lateral load bearing systems in seismic areas. Despite several studies, there is no detailed and trustworthy information about the behavior of these systems under dynamic and seismic loading. This issue is more

enigmatic in concrete structures as almost all concrete beam to column connections are basically rigid and construct flexible connection is not prevalent in concrete structures. However, in low-rise buildings, the flexibility provided by semi-rigid and flexible connections might result in lesser inertia forces and, consequently, smaller deformations. This can lead to optimal design and how it can be approached. Therefore, the researchers have shown their interest in studying the behavior of these systems in low-rise buildings in seismic zones.

The non-linear analyses of frames with semi-rigid connections have shown that using semi-rigid connections lead to lower stress response in beams and columns due to the reduction of global seismic demands. Researchers have also shown that replacing rigid connections with semi-rigid ones in low-rise buildings lead to lower base shear, higher ductility, and more economical construction. Nader and Astaneh [10,12] studied 44 shake table tests and compared the behavior of three types of connection and commented on the use of flexible and semi-rigid structures in seismic zones. They concluded that “as the stiffness of the connection increased, the base shear resulting from the same ground motion increased, while the corresponding lateral drift did not decrease in a similar manner”. They also argued that flexible and semi-rigid structures have considerable potential for

Corresponding author, E-mail: mirjalili@yazd.ac.ir

resisting earthquake loading, and need further study. Elnashai and Mahmoud [5] studied the performance of low-rise long-span frames with semi-rigid connections by evaluating 26 sample models under three different earthquake levels. In an experimental and analytical study, Elnashai and Elghazouli [11, 14] showed that the frames with semi-rigid connections demonstrate adequate and in some cases favorable seismic resisting behavior. It was shown that semi-rigid frames exhibit a ductile and stable hysteretic behavior. All of mentioned references have been restricted to steel flexible and semi-rigid connections. There has not been any serious study and comprehensive investigation on using semi-rigid connections in concrete buildings. This is due to the fact that concrete beam to column connections are basically rigid, so, using and constructing the flexible and semi-rigid connections in these structures is not practical.

In this paper, a new semi-rigid concrete connection is proposed and its behavior is investigated experimentally. Moreover, the effect of using proposed connection on seismic demands is evaluated analytically. In this connection, the beam does not directly connect to column but instead the beam connects to column with torsional connecting element. This scissor mechanism allows the beam to have some flexible rotation with respect to column. For interior frames, two beams are required instead one which pass on mutual faces of column. In this mechanism, the connection of beam to column is based on a torsional connecting member that is located between beam and column. Therefore, the end beam moment has been conducted to column among torsional mechanism. Torsional stiffness of connector allows the beam to have some flexible rotation with respect to column. The connection is schematically shown in Figure 1. The issue of torsion in reinforced concrete elements has widely been investigated by researchers [20-23]. In this study, the behavior of proposed connection under cyclic loading evaluated using several experimental tests. As it was mentioned before, the insufficient stiffness and strength of flexible connections cause these systems not be applicable in high seismic zone sites. The basic proposed connection belongs to these types of connections which can be used in low hazard earthquake zones or low rise buildings. To spread the application range of the proposed connection for higher buildings or for the structures located in high risk seismic areas, the strengthened connections are suggested to support higher levels of lateral deformations. For this purpose, two techniques are proposed and investigated experimentally. The recommended techniques for strengthening of the torsional connector are: i) CFRP wrapping, and ii) reinforcing with steel core. Detailed descriptions of test arrangement and specimens, load sequences, test methods and data acquisition techniques are given. The general observed behavior is discussed. Moreover, the analytical model for the proposed connection is presented and verified with experimental results. To investigate the effect of using the semi-rigid connection in low-rise concrete buildings, two 3-story models with rigid and semi-rigid connections are analyzed using nonlinear time history analyses with several appropriate ground motion records and the obtained results of various responses are compared.

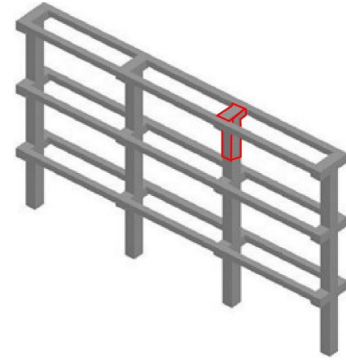

Figure 1. The schematic presentation of proposed semi-rigid connections in reinforced concrete frame

## 2- Experimental details and methodology

### 2- 1- Specimens and Material Details

The connection model used in the test setup was specified in frame model as shown in Figure 1. In this study, behavior of the torsional elements of connection was studied under the torsional moment and lateral shear force was induced in connection due to seismic forces. In other words, it is assumed that the frame shown in figure 1 is only lateral resisting frame and not any gravity loads is imposed to beams. Therefore, the interaction of torsion and shear force from gravity loads is not considered in this study and, therefore, the axial force of column is removed in test procedure. Experiments were carried out on three specimens: i) a basic sample as the control specimen (S1), ii) a specimen in which the torsional member was strengthened with CFRP wrapping (S2), and iii) a specimen in which the torsional member was reinforced by steel core (S3).

The specimens are shown in Figure 2 and their specification is listed in Table 1. In all specimens, torsional element dimension is  $100 \times 19 \times 19 \text{ cm}^3$  and column dimension is  $105 \times 19 \times 14 \text{ cm}^3$  (Figure 2a). The reinforcement layout is presented in Figure 3. The spacing between torsional ties was taken 4 cm according to minimum value determined by section 25.2.3 of ACI 318-14 [24]. The concrete compressive strength was  $f_c = 38.5 \text{ MPa}$  resulted from compression test. Table 2 provides mechanical properties of steel reinforcement obtained using direct tensile tests. For analytical part of study, the yield strength of reinforcement bars was taken as  $f_y = 400 \text{ MPa}$  for longitudinal bars and  $f_y = 300 \text{ MPa}$  for transverse bars. ST37 grade with the yield strength  $f_y = 240 \text{ MPa}$  and modulus of Elasticity  $E = 196 \text{ GPa}$  is chosen for the steel core. Table 3 summarizes the mechanical properties of fabric, cured CFRP sheet, and resin components provided by the manufacturer. Specifications of specimens are presented in Figure 4.

Table 1. The specimen's description

specimens	Properties
S1	Basic sample without any strengthening
S2	Strengthened sample with CFRP wrapping
S3	Strengthened sample with steel core

**Table 2. Mechanical properties of steel reinforcement**

Bar diameter (mm)	Stress (MPa)		Elastic Modulus (GPa)
	Yield	Ultimate	
8	315	510	193
16	420	621	201

**Table 3. Mechanical properties of composite materials**

Material	Tensile strength (MPa)	Ultimate strain (%)	Tensile modulus (GPa)	Thickness (mm)
Fiber	4950	1.63	245	0.18
Cured CFRP	470	1.32	34	1
Resin	28	0.9	4.3	-

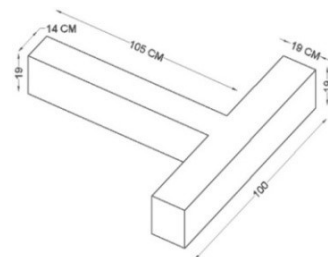

(a) framework dimensions



(b) basic specimen



(c) CFRP specimen

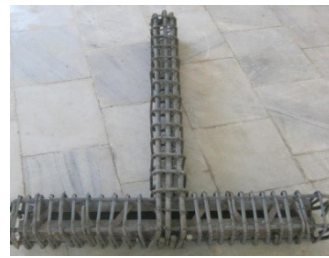

(d) steel core specimen

**Figure 2. Specimens used for experimental study**

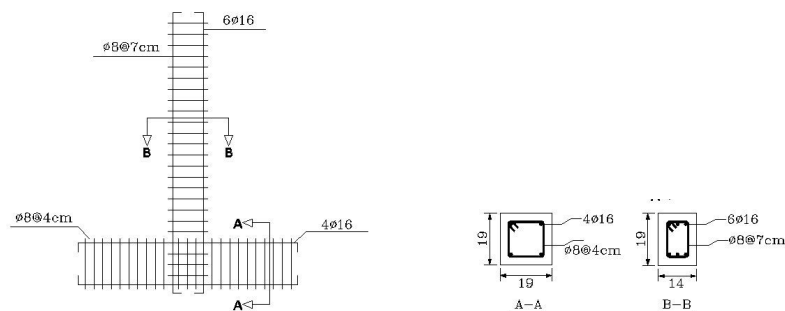

**Figure 3. The reinforcement pattern of specimens**

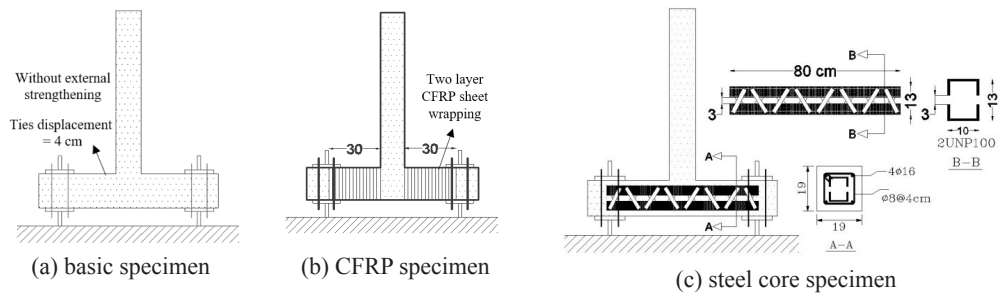

Figure 4. structural details of specimens

## 2- 2- Test set-up, Loading Procedure and Instrumentation

The test set-up is shown in Figure 5. The torsional elements of specimens were attached to the supports in such a way that the complete torsional restriction was provided. To avoid distortion of torsional element at supports, two bearing plates were located at top and bottom of element ends. Moreover, T steel profile was used to fix the supports. The number of rods were conservatively selected to avoid significant deformation. The specimens were subjected to cyclic lateral displacement induced by an actuator at the top point of column as it shown in Figure 5. The lateral load was applied in a displacement control mode using a horizontally aligned 100 kN hydraulic actuator having maximum stroke of  $\pm 150$  mm. For all specimens, displacement increment amplitudes were set to 2, 4, 8, 16, 32 and 64 mm. According to the ACI T1.1-01 [25] requirements, each displacement level consisted of three complete reversed cycles to properly assess the deteriorating behavior and stiffness degradation. The scheme of lateral displacement is shown in Figure 6. Experimental results were recorded continuously using load cell and displacement transducer located in the actuator arm, and external LVDT (linear varying displacement transducer) attached to the column face and ground. To calculate the torsional moment of connection, the measured lateral load should be multiplied by lever arm length which is equal to the distance of loading point from center line of torsional element section. To obtain the relative angular deformation (twist angle), the diagonal elongation read by LVDT was converted to the angular deformation using mathematical conversion equations. The LVDT setup is depicted in more details in Figure 5. As shown, the LVDT reads the diagonal displacement while two ends of LVDT are restrained from slipping. Therefore, assigning specific constant length for parameter “a”, the torsion angle can be expressed by the length of chord which can be reported by LVDT. In this way, the torsional angle can be directly calculated independently from flexural deformation of column. Moreover, having lateral displacement from actuator, one could have extracted the flexural displacement of column.

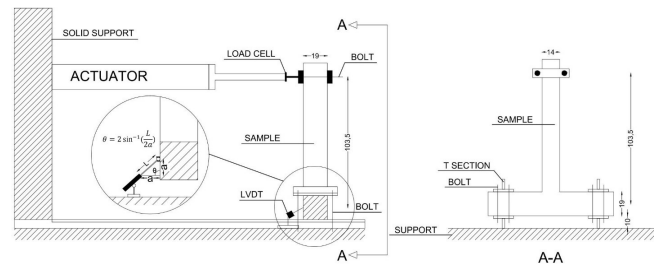

Figure 5. Test set-up arrangement

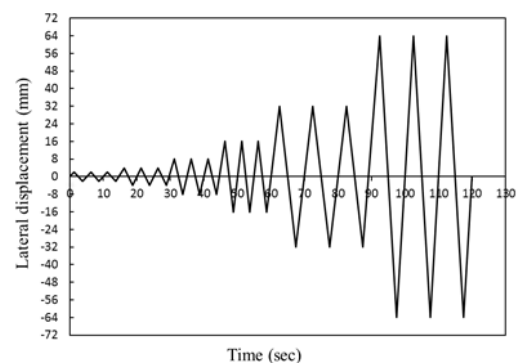

Figure 6. Cyclic loading scheme of lateral displacement

## 2- 3- Presentation and analysis of results

### 2- 3- 1- Moment-rotation response

The hysteresis curves of moment-rotation response for studied specimens under cyclic loading are presented in Figure 7. As it can be seen, the torsional deformation

(twist angle) of torsional elements provide considerable flexibility for connection. The non-linear torsional behavior of the connection can control and reduce induced moment in column, preventing the plastic hinge formation. The comparison of moment-rotation hysteresis and envelope response of basic and strengthened specimens is presented in Figures 7 and 8. The envelope curves contain the peak responses of each cycle. As it can be seen in Figure 8, the strengthened specimens exhibit more convenient behavior compared with basic specimen. All specimens have almost symmetric behavior in reverse loading. The moment capacity of proposed connections corresponding to rotation angle of 0.027 Radian is presented in Table 4. All specimens exhibited almost similar behavior under small deformations. This

indicated that when deformations are limited (e.g. non-sway frames), the strengthened methods can not significantly improve the stiffness and capacity of connection. However, under moderate torsional deformations, when the torsional member started to exhibit non-linear behavior and stiffness degradation, specimen S3 (reinforced with steel core) have had the best behavior due to high torsional capacity of steel element embedded in concrete section. In extensive torsional deformations, the specimen S2 (CFRP wrapped) do better which is because of high confinement of concrete section due to CFRP strips avoiding degradation of element concrete. It can be concluded that the CFRP wrapping significantly increased the torsional ductility of proposed connection. Anyway, both strengthened specimens showed a ductile and stable hysteretic behavior under cyclic loading.

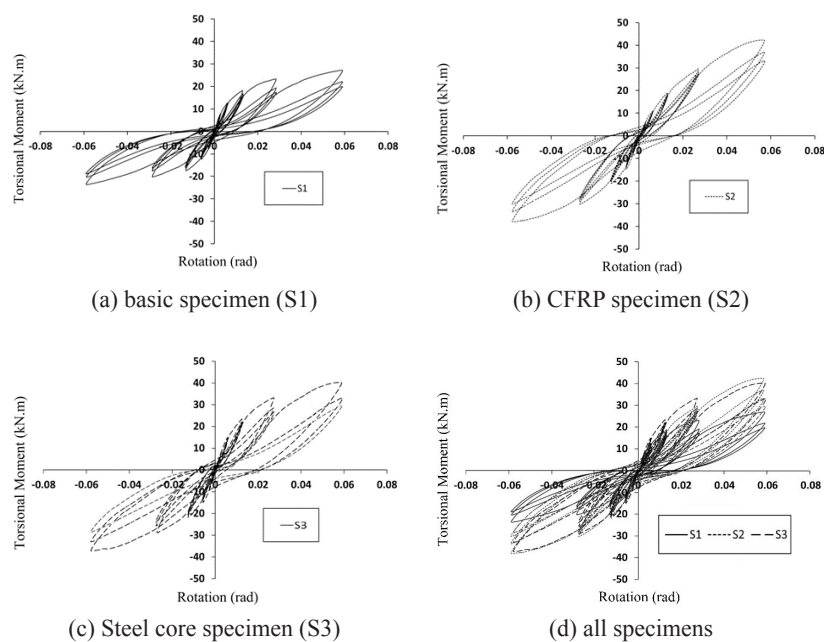

Figure 7. Moment-rotation hysteresis curves

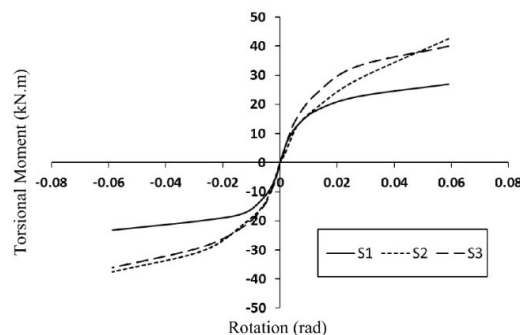

Figure 8. Moment-rotation envelope curves

**Table 4. Experimental Results of Specimens**

Specimens	Moment Capacity (kN.m)	Normalized Stiffness (kN.m/rad)	Energy Dissipation (kN.m)
S1	23	0.08	0.16
S2	30	0.18	0.185
S3	33	0.11	0.198

**2- 3- 2- Stiffness degradation**

As shown in Figure 8, all specimens had almost identical initial torsional stiffness denoted by  $K_0$ . In this study, the tangent torsional stiffness ( $K_t$ ) at different deformations is used as a reference for comparing the stiffness behavior of basic and strengthened specimens. The normalized tangent stiffness defined as ( $K_t/K_0$ ) under various torsional deformation for studied specimens is illustrated in Figure 9. The normalized tangent stiffness of proposed connections corresponding to rotation angle of 0.02 radian is presented in Table 4. As it can be seen, the specimen S2 (CFRP wrapped) exhibited the best stiffness consistency under different torsional deformations. This indicated that CFRP wrapping of torsional member has a substantial effect in avoiding the stiffness degradation. Specimen S3 (reinforced with steel core) also shows a better stiffness behavior than basic specimen due to high stiffness of steel profile embedded in concrete section.

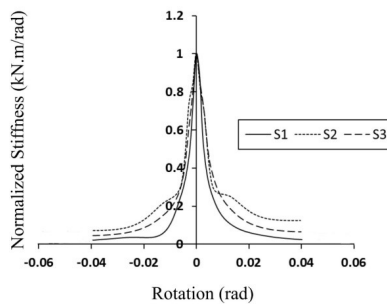

**Figure 9. Normalized tangent stiffness of studied connections**

**2- 3- 3- Energy dissipation**

High energy dissipation is a desirable characteristic in seismic performance of structural elements. The energy dissipation is equal to the enclosed area by cycle of the torsional moment versus rotation (twist) hysteretic curves. The energy dissipated at a given twist angle is calculated as the average energy of all hysteretic cycles at this rotation. Figure 10 shows the amount of cumulative energy dissipated at various rotation (twist angle) for the tested specimens.

It can be observed that in low levels of deformation (up to 0.01 rad.), all specimens exhibited the same behavior and there was not significant energy dissipation. The little energy dissipation at the small deformation was due to the absence of any significant damage such as concrete spalling and bar yielding. At higher levels of deformation, specimens S2 (CFRP wrapped) and S3 (reinforced with steel core) started to show superior behavior with increasing nonlinear deformation. The amount of energy dissipation of proposed

connections corresponding to rotation angle of 0.02 radian as presented in Table 4. It is respectively increased by 16% and 24% in specimens S2 and S3 compared to non-strengthened specimen S1.

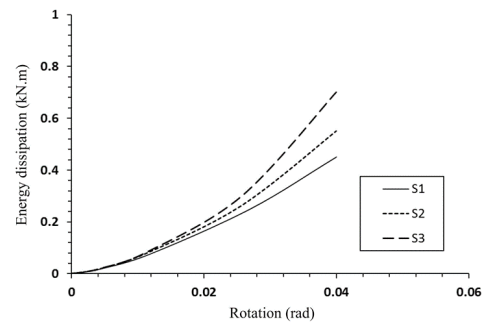

**Figure 10. Cumulative energy dissipation of torsional connections for the tested specimens**

**2- 3- 4- Failure modes**

The cracks appeared in all specimens due to shear failure causing from torsional deformation. The crack pattern along different loading levels including the reversal loading are shown in Fig. 11.

**3- Numerical study**

In this section, the finite element modeling procedure was adopted as an analytical study to predict the torsional response of proposed basic (without strengthening) connection. Finite element investigation on reinforced concrete members subjected to flexure and shear have been extensively carried out by researchers while there are not considerable numerical studies on the behavior of RC members under torsion [26]. In this study, ABAQUS finite element framework has been used in order to simulate full-scale torsional element of connection in both linear and non-linear range of responses and the results were compared with the experiment. The closeness of numerical and experimental results would confirm the proposed modeling assumptions. Therefore, the same modeling approach can be applied for estimating the torsional behavior of any similar conditions. The details of modeling are discussed in the following.

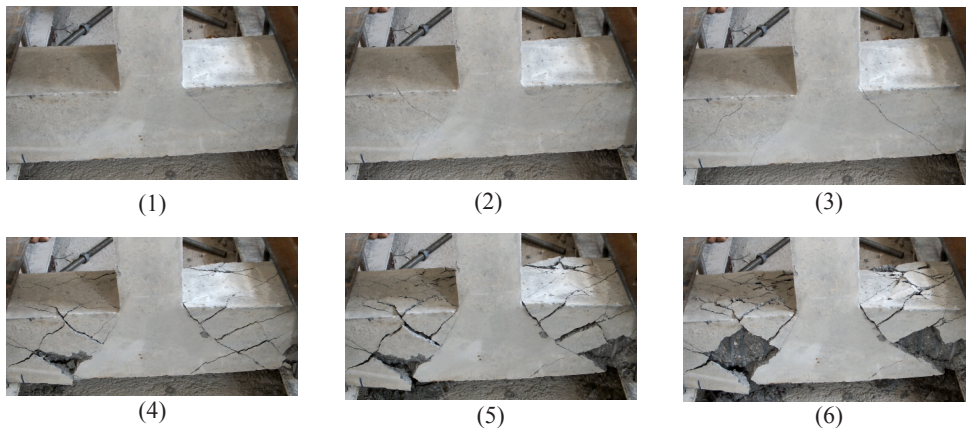

Figure 11. Failure mode and crack patterns in different stages of lateral loading

### 3- 1- Description of the numerical model

Concrete was modeled using three dimensional eight node solid brick elements with three translational degrees of freedom at each node. Parabolic model was used to define the compressive stress-strain backbone curve. To model the post-cracking behavior, tension stiffening behavior was considered for concrete under tension according to suggested exponential model by Greene [27]. The backbone curve of stress-strain relation for concrete and reinforcing bars is shown in Figure 12. Longitudinal and transverse reinforcing steel bars were modeled with three dimensional, two node truss elements with elastic perfectly plastic stress strain relationship. The concrete steel interaction was modeled using embedded region constraint. The bond slip between concrete and steel under torsional loading is insignificant [28], hence, perfect bond could be assumed to define the interaction between concrete and reinforcing steel. Explicit integration technique was used to solve the non-linear problem. To model the basic specimen under the test condition, a torsional beam with fixed boundary condition at both ends was considered. The twist deformation according to experimental results was applied at the center of beam. The simulation was carried out in displacement controlled scheme.

### 3- 2- Comparison of numerical and experimental results

The purpose is to validate the numerical predictions with the experimental results. Predicted and experimental results are compared for a basic specimen. The moment-rotation (torque-twist) backbone curves obtained from analysis and test is illustrated in Figure 13. The elastic (pre-cracked) behavior predicted by the numerical model is close to the observed behavior. As it can be seen, the finite elements model has accurately predicted the cracking torque ( $T_{cr}$ ) and cracking twist ( $\theta_{cr}$ ). In post cracking twist deformation, the estimated results obtained from numerical analysis contained some small errors but they are still in acceptable range and a reasonable match can be found between the model and test results. The boundary condition consideration and steel-concrete bond characteristics modeling approach played an important role in the predictions of finite element analysis especially in the non-linear range of responses.

The above comparison study was carried out to verify accuracy and reliability of backbone curve obtained from numerical modeling approach implemented within ABAQUS. The obtained non-linear behavior would be used with confidence in structural non-linear modeling of building with the proposed semi-rigid connection.

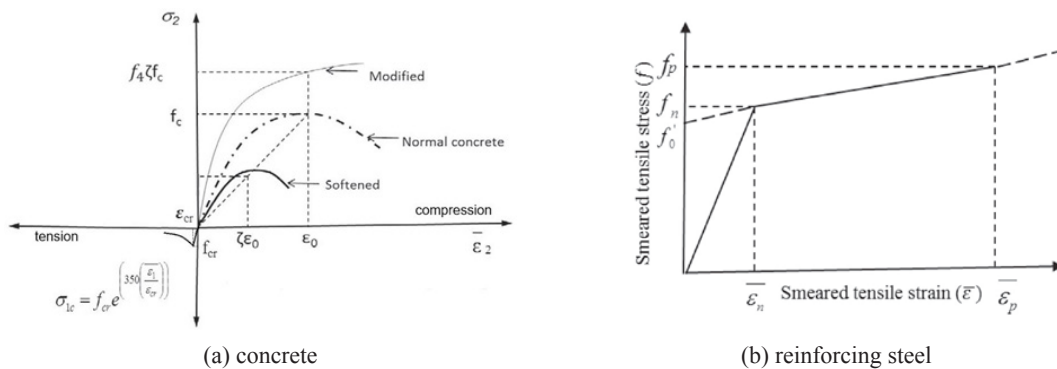
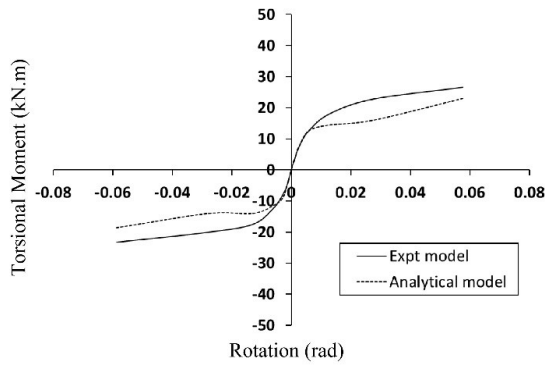

Figure 12. Stress-strain backbone curves for nonlinear modeling of concrete and reinforcing steel



**Figure 13. Comparison of numerical analysis result and experimental data for torsional moment-rotation backbone curve**

#### 4- Influence of connection on frame seismic behavior

In this section, the effect of beam-column connection flexibility on the seismic demands induced in structural members of reinforced concrete (RC) buildings was investigated. As it was mentioned before, extensive studies have been carried out by researchers for flexible and semi-rigid steel connections, but, there is no comprehensive research on semi-rigid connections in RC buildings. For this purpose, first, two 3-story RC model, one with rigid connections and another with proposed torsional semi-rigid connections, were designed according to seismic design codes ASCE7-10 [29] and ACI318-14 [24]. Then, based on design sections, the nonlinear models were constructed using OpenSees framework [30]. The non-linear time-history analyses with several ground motions were performed on models and the obtained results were compared.

##### 4- 1- Description of models

Two three-story three-bay symmetric building (2-d frame) were considered, one with rigid connections, another with proposed semi-rigid connections. Dimensions and configuration of the structural models are presented in Figure 14. The concrete compressive design strength was taken  $f_c=35$  MPa and the AIII grade of reinforcing steel with yield strength equal to  $f_y=400$  MPa was chosen for design purpose. Gravity and seismic loads and load combinations were determined according to ASCE 7-10 [29]. For gravity loads, a dead load of 28.8 kN/m was applied to both the floors and the roof. The live load was taken as 9.00 kN/m for the roof and 34.2 kN/m (contain partition walls) for the floors (office building). The buildings were assumed to be founded on an area classified as soil category D. The seismic loads were calculated and applied to the system according to the equivalent lateral force procedure of ASCE 7-10 [29] using code spectrum properties from USGS [31] for a location in Los Angeles. The design element sections are shown in Figure 14.

For non-linear modeling of described structures, the open source finite element framework ‘OpenSees’ [30] was used. A non-linear beam-column element with ‘fiber’ section considering distributed plasticity was utilized to model beam and column elements in the moment resisting and semi-rigid frame models. The ‘concrete01’ and ‘concrete02’ materials were selected for concrete modeling of column and beam

sections, respectively. The ‘reinforcing steel’ material was used for reinforcing bars. The ‘hysteretic’ material was utilized for modeling the nonlinear behavior of semi-rigid connection. For this purpose, the designed torsional elements of semi-rigid connections, was modeled in ABAQUS with pre-proposed modeling approach and the obtained torque-twist curves were defined in form of ‘hysteretic’ material behavior in OpenSees [30]. Non-linear time history analyses were performed using implicit Modified Newton-Raphson method in which the tangent stiffness was not updated within each time step to avoid lengthy calculations. The Rayleigh damping matrix was defined considering 5% damping ratios for the first and third modes of the structural models. The initial stiffness matrix of the building was used to generate the Rayleigh damping matrix.

Seven far-field ground motion records were selected from the recommended set in FEMA-P695 [32] that were recorded on soil type D, and scaled according to the ASCE 7-10 [29] procedure for a location in L.A. The selected ground motions and their scale factors are listed in Table 2.

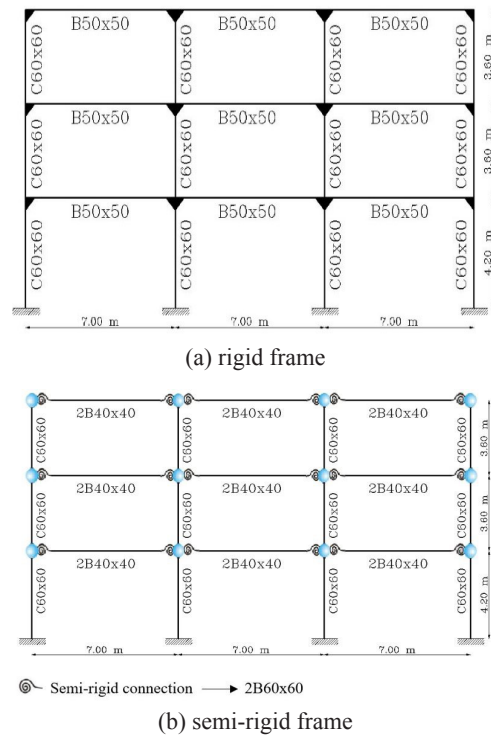

**Figure 14. Configuration and element sections of the structural models**

##### 4- 2- Results of numerical analysis

The seismic demands of structural models are compared. For this purpose, the story shear, the inter-story drift, exterior column flexural moment, axial force and interior beam moment response were used for comparison. The results are presented in Figure 15. As it can be seen, the story shear responses in semi-rigid model are smaller than those in rigid model. This is due to smaller lateral stiffness and lower level of induced seismic force. The story shear responses at story 1



to 3 in semi-rigid model are respectively 8, 12 and 5 percent of corresponding result in rigid model. The inter-story drift responses in semi-rigid model is not very considerably larger than rigid model, despite having smaller stiffness frames. The moment demands induced in beam elements in semi-rigid frame are considerably smaller than rigid frame due to lower flexural stiffness of semi-rigid connections. This can

significantly prevent the weak-column strong-beam design in lateral resisting frames. There is not very significant difference in the column elements seismic demands.

In general it can be concluded that in low-rise building in which the lateral displacements are limited, the frames with semi-rigid connections are more economical. The non-linear seismic demands especially story shear and beam moments can be reduced using semi-rigid connections.

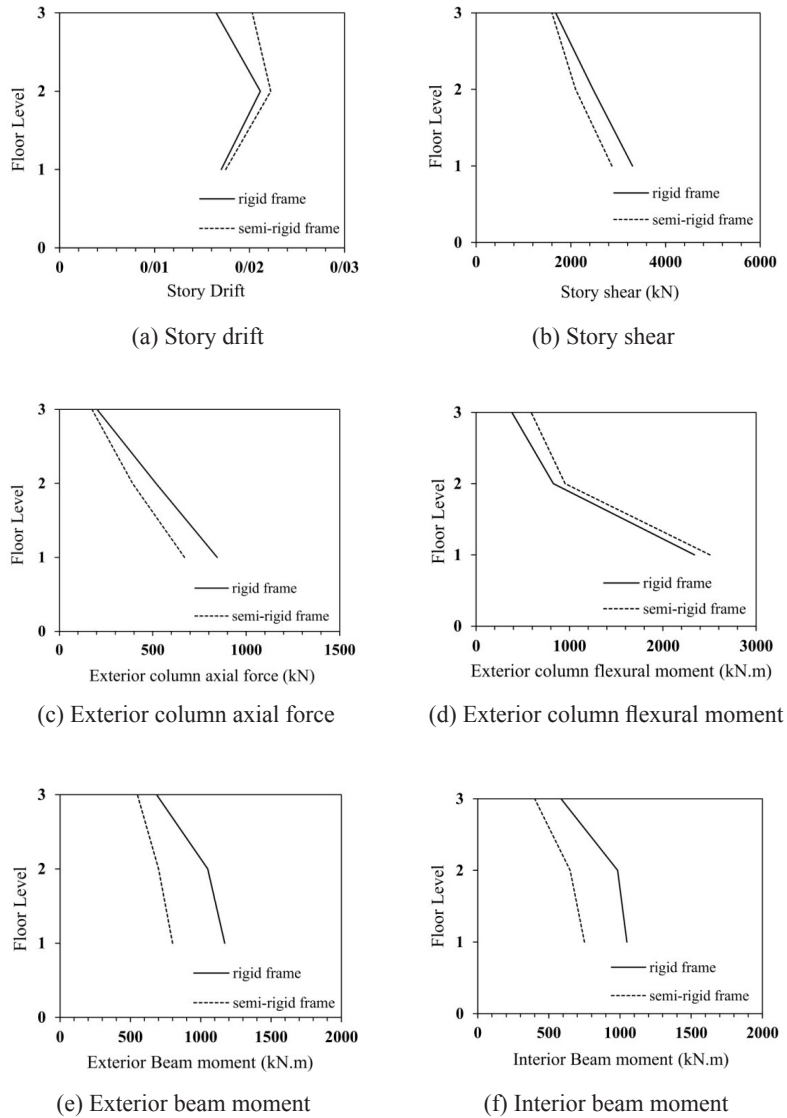

Figure 15. Results of comparative study of rigid and semi-rigid models

**Table 5. The details of the strong ground motion records considered in this study**

EQ ID	Earthquake	Recording Station	M	Year	Fault Type	PGA(g)	PGV (cm/s)	Scale factors	
								Rigid Frame	Semi-rigid Frame
EQ01	Northridge	Beverly Hills	6.7	1994	Thrust	0.52	57.2	0.77	0.68
EQ02	Northridge	Canyon Country	6.7	1994	Thrust	0.48	44.8	1.43	1.29
EQ03	Imperial Valley	El Centro Array	6.5	1979	Strike-slip	0.38	36.7	3.57	2.98
EQ04	Kobe, Japan	Shin-Osaka	6.9	1995	Strike-slip	0.24	33.9	3.01	2.03
EQ05	Landers	Coolwater	7.3	1992	Strike-slip	0.42	32.4	1.67	1.71
EQ06	Loma Prieta	Gilroy Array	6.9	1989	Strike-slip	0.56	37	3.81	2.67
EQ07	San Fernando	Hollywood Stor	6.6	1971	Thrust	0.21	30	3.36	2.98

## 5- Conclusions

In this paper, a semi-rigid concrete connection was proposed and its behavior was investigated experimentally. The connection of beam to column is based on torsional mechanism using a torsional member as connector. Torsional stiffness of connector allows the beam to have flexible rotation with respect to column. To enhance the seismic performance of the connection, two strengthening techniques, i) CFRP wrapping and ii) reinforcing with steel core, were proposed. The behavior of proposed connections was evaluated under cyclic loading using several experimental tests. All specimens exhibited almost similar behavior under small deformations. This indicated that when deformations are limited (e.g. non-sway frames or low-rise buildings), the basic (not strengthened) connection can comfortably be used in structure. Under moderate torsional deformations, specimen S3 (with steel core) had the best behavior due to high torsional capacity of steel element. In extensive torsional deformations, the specimen S2 (CFRP wrapped) showed a better behavior, because of high confinement of concrete section due to CFRP strips that prevent degradation of element concrete. Anyway, both strengthened specimens exhibited a ductile and stable hysteretic behavior under cyclic loading. Beside the experimental study, the analytical modeling approach for the proposed connection was presented and verified with experimental results. The proposed modeling method was used to simulate the non-linear behavior of semi-rigid connection which later should be considered in structural models. To evaluate the efficiency and effect of proposed connection in reduction of seismic demands in structural members, two models with rigid and semi-rigid connections were considered. The results showed that some seismic demands such as the story shear response and beam moment demands decreased and some seismic demands like story drift, column axial force and moment demands increased insignificantly. The story drift responses in semi-rigid model were not very considerably larger than those in rigid model, despite smaller stiffness of frames. The considered models in this study were 3-story buildings in which the lateral displacements were not so large. In mid- and high-rise buildings where there are

significant lateral displacements and deformations, the semi-rigid frames do not have adequate lateral stiffness to resist the seismic loads and should be used in combination with rigid or braced frames. So, the proposed connection can be used in low-rise buildings. Using semi-rigid frames can also prevent weak-column strong-beam design in the structures with long beam spans. In these cases, the semi-rigid frames can be more efficient and economical than rigid frames. In this study, only the effect of basic connection (not strengthened connection) on seismic demands is investigated. The influence of proposed strengthening connections in global and local forces and deformations should be surveyed comprehensively in more studies.

## References

- [1] W.F. Chen, N. Kishi, Semi-rigid steel beam-to-column connections: data base and modeling, *Journal of Structural Engineering*, 115 (1989) 105–19.
- [2] Y. Yu, X. Zhu, Nonlinear dynamic collapse analysis of semi-rigid steel frames based on the finite particle method, *Engineering Structures*, 118 (2016) 383-393.
- [3] S. Akavci, Nonlinear analysis of semi-rigid frames with rigid end sections, *Iranian Journal of Science & Technology, Transactions of Civil Engineering*, 31 (2007) 567-571.
- [4] J.G.S. Da Silva, L.R.O. de Lima, P.C.G. da S, S.A.L. de Andrade, R.A. de Castro, Nonlinear dynamic analysis of steel portal frames with semi-rigid connections, *Engineering Structures*, 30 (2008) 2566-2579.
- [5] S. Elnashai, H. Mahmoud, The design and seismic performance of low-rise long-span frames with semi-rigid connections, *Journal of Constructional Steel Research*, 67 (2011) 114-126.
- [6] K.H. Lien, Y.J. Chiou, P.A. Hsiao, Vector form intrinsic finite-element analysis of steel frames with semi-rigid joints, *Journal of Structural Engineering*, 38 (2012) 27–36.

- [7] V. Vimonsatit, S. Tangaramvong, F. Tin-Loi, Second-order elastoplastic analysis of semirigid steel frames under cyclic loading, *Engineering Structures*, 45 (2012) 127–36.
- [8] P.C. Nguyen, S.E. Kim, Nonlinear elastic dynamic analysis of space steel frames with semi-rigid connections, *Journal of Constructional Steel Research*, 84 (2013) 72–81.
- [9] L. Xu, Second-order analysis for semirigid steel frame design, *Canadian Journal of Civil Engineering*, 28 (2001) 59-76.
- [10] M.N. Nader, A. Astaneh, Dynamic behavior of flexible, semirigid and rigid steel frames, *Journal of Constructional Steel Research*, 18 (1991) 179-192.
- [11] A.S. Elnashai, A.Y. Elghazouli, seismic behavior of semi-rigid steel frames, *Journal of Constructional Steel Research*, 29 (1994) 149-174.
- [12] M.N. Nader, A. Astaneh, Shaking Table tests of rigid, semirigid, and flexible steel frames, *Journal of Structural Engineering*, 122 (1996).
- [13] J.Y.R. Liew, C.H. Yu, Y.H. Ng, N.E. Shanmugam, Testing of semi-rigid unbraced frames for calibration of second-order inelastic analysis, *Journal of Constructional Steel Research*, 41 (1997) 159-195.
- [14] A.S. Elnashai, A.Y. Elghazouli, Response of semi rigid steel frames to cyclic and earthquake loads, *Journal of Structural Engineering*, 124 (1998) 124.
- [15] Y. Goto, S. Miyashita, Classification system for rigid and semirigid connection, *Journal of Structural Engineering*, 124 (1998) 750-757.
- [16] A. Loureiro, A. Moreno, R. Gutiérrez, J.M. Reinoso, Experimental and numerical analysis of three-dimensional semi-rigid steel joints under non-proportional loading, *Engineering Structures*, 38 (2012) 68–77.
- [17] B. Gil, R. Goñi, E. Bayo, Experimental and numerical validation of a new design for three-dimensional semi-rigid composite joints, *Engineering Structures*, 48 (2013) 55-69.
- [18] SSRC (Structural Stability Research Council), *Connection Bibliography*, Task Group 25, Bethlehem, PA, (1990).
- [19] D.A. Nethercot, Steel beam-to-column connections, a review of test data and their applicability to the evaluation of the joint behaviour of the performance of steel frames, CIRIA Project Record, RP338, (1985).
- [20] M.R. Mohammadzadeh, M.J. Fadaee, Experimental and analytical study on behaviour of CFRP-strengthened beams with minimum reinforcement under pure torsion, *Iranian Journal of Science & Technology, Transactions of Civil Engineering*, 34 (2005) 35-48.
- [21] C.E. Chalioris, Experimental study of the torsion of reinforced concrete members, *Structural Engineering and Mechanics*, 23 (2006) 713-737.
- [22] A.H. Khagehhosseini, R. Porhosseini, R. Morshed, A. Eslami, An experimental and numerical investigation on the effect of longitudinal reinforcements in torsional resistance of RC beams, *Structural Engineering and Mechanics*, 47 (2013).
- [23] A.A. Majeed, A.A. Allawi, K.H. Chai, H.W. Wan Badaruzzam, Behavior of CFRP strengthened RC multicell box girders under torsion, *Structural Engineering and Mechanics*, 61 (2017) 397-406.
- [24] American Concrete Institute, Building code requirements for structural concrete and commentary: ACI 318, Farmington Hills, MI, USA, (2014).
- [25] American Concrete Institute, ACI Innovation Task Group 1 and Collaborators, Acceptance Criteria for Moment Frames Based on structural Testing and Commentary: ACI T1.1-01, (2001).
- [26] A. Ganganagoudar, T.G. Mondal, S.S. Prakash, Analytical and finite element studies on behavior of FRP strengthened RC beams under torsion, *Composite Structures*, 153 (2016) 876-885.
- [27] G.G. Greene, Behavior of reinforced concrete girders under cyclic torsion and torsion combined with shear: Experimental investigation and analytical models, Ph.D. Dissertation, University of Missouri, Rolla, (2006).
- [28] G. Hurtado, Effect of torsion on the flexural ductility of reinforced concrete bridge columns, Ph.D. Dissertation, University of California, Berkeley, (2009).
- [29] American Society of Civil Engineers, Minimum Design Loads for Buildings and Other Structures: ASCE 7-10, Reston, Virginia, (2010).
- [30] OpenSees, Open system for earthquake engineering simulation, (2004).
- [31] U.S. Seismic Design Maps: USGS, (2015), Available in <http://earthquake.usgs.gov/designmaps/us/application.php>.
- [32] Federal Emergency Management Agency, Quantification of Building Seismic Performance Factors: FEMA-P695, Washington, USA, (2009).

Please cite this article using:

R. Morshed, H. R. Shayegh, M. R. Mirjalili, Experimental and analytical study of new proposed semi-rigid concrete beam-to-column connection, *AUT J. Civil Eng.*, 3(1) (2019) 49-60.  
DOI: 10.22060/ajce.2018.14987.5511



